

High Pressure Sodium Core & Coil Ballast Kit

47647 LU400/SUPER5-KIT

FOR ONE 400 WATT, S51 HPS

Line Voltage	120/208/240/277/480V
Regulation	
Line Volts	+/-10%
Line Watts	WHITIN TRAPEZOID
Frequency	60 Hz
Circuit Type	CWA
Power Factor (min)	90%
Insulation Class	H(180°)
Min. Ambient Starting Temp.	-40° F or -40° C

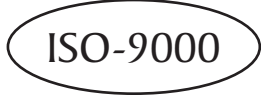

Line Voltage (Volts)	120	208	240	277	480
Line Current (Amps)					
Operating	3.8	2.2	1.9	1.7	1.0
Open Circuit	2.0	1.3	1.0	0.9	0.5
Starting	3.15	1.85	1.6	1.4	0.8
Input Watts (W)	464	464	464	464	464
Open Circuit Voltage (V)	190	190	190	190	190
Drop Out Voltage (V)	86	150	171	193	335
UL(1029) Bench Top Rise	C	C	C	C	C
Recommended Fuse (Amps)	10	6	5	5	3

HIGH POTENTIAL TEST (VOLTS)	
1 Minute	2000
2 Seconds	2500
Open Circuit Voltage Test (volts)	177 - 210
Short-Circuit Current Test (Amps)	
Secondary Current	6.3 - 7.2
Input Current (Amps)	2.85- 3.15 1.65- 1.85 1.42- 1.57 1.22- 1.35 0.71- 0.79

4 1/4" x 4 3/4" CORE

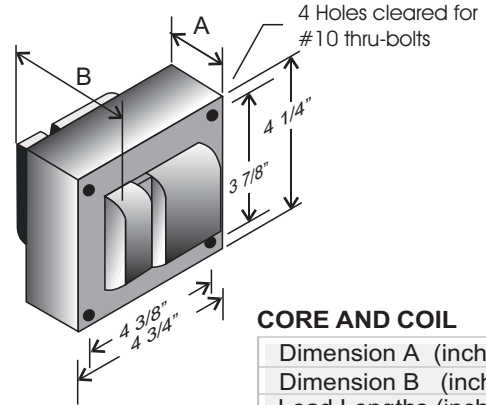

CORE AND COIL

Dimension A (inches)	2.72
Dimension B (inches)	4.80
Lead Lengths (inches)	12

IGNITOR 37-63-AS-6.9-N6

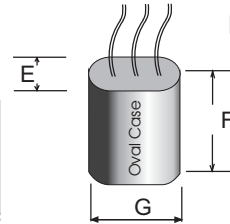

(THERMAL PLASTIC CASE)

Max. case temp
110° C

NAED: XXXXX

Dimension E (inches)	1.17
Dimension F (inches)	2.5
Dimension G (inches)	1.9

Maximum Distance To Lamp: 2 feet

BRACKET CORE & COIL MOUNTING BRACKET

NAED: XXXXX

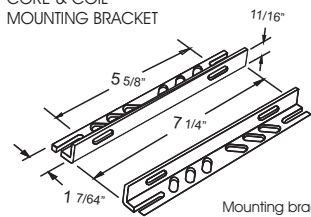

Mounting bracket for
Core & Coil Ballasts
(2 brackets with thru bolts)

NAED: XXXXX

MOUNTING CLIP for round
case (Furnished as standard
with B suffix ballast)

NAED: XXXXX

MOUNTING CLIP for oval
case (Furnished as standard
with B suffix ballast)

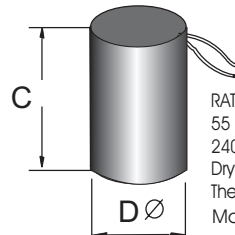

CAPACITOR

NAED: XXXXX

RATING
55 Mfd ± 3%
240 VAC MIN
Dry Film Capacitor
Thermal Plastic Case
Max. Case Temp 100° C
NO PCB'S

Dimension C (inches)	5.00
Dimension D (inches)	1.75

PRODUCT LABEL

SYLVANIA Lamp Type
S51 400W HPS

LU400/SUPER5-KIT



120/208/240/277/480V
3.8/2.2/1.9/1.7/1.0 A
190Voc, 60Hz, CWA

1029C Class H
Ground Ballast Core
86-180-4

47647-4

Made in Mexico

Caution: High Voltage Pulse Present on Open Circuit

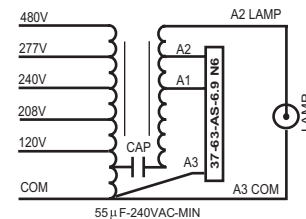

CARTON LABEL

SYLVANIA 1 Ballast Kit 1 SKU's

LU400/SUPER5-KIT S51

LUMALUX® 120/208/240/277/480V

Magnetic Ballast / Ballast magnétique Mexico

47647-4



1 00 46135 47647 8

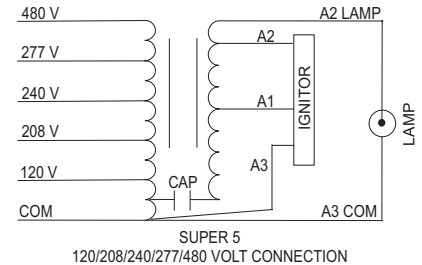

WIRING DIAGRAM F

CARTON CHARACTERISTICS

UNITS CARTON	CARTON/LAYER	# OF LAYERS	UNITS PALLET	PIECE WEIGHT	CARTON WEIGHT	PALLET WEIGHT
1	30	4	120	14.59 Lbs	14.99 Lbs	1834.56 Lbs
CARTON PALLET	CARTON DIMENSIONS	PALLET DIMENSIONS	PALLET DIMENSIONS LOADED, INCLUDING WOOD PALLET			
120	8.7" x 5.9" x 5.1"	40" x 48" x 7"	40" x 48" x 27.56"			

Item Number 47647 LU400/SUPER5-KIT

HIGH PRESSURE SODIUM Line Voltage

Primary Lamp Wattage